

End Fed Antennas for Portable, Emergency & Stealth Installations



Bob Brehm, AK6R
Chief Engineer
Palomar-Engineers.com

BLINDHAMS.COM – July 21, 2022
This presentation available on website
Copyright 2013-2022 Palomar Engineers, Inc.

Palomar History

- Founded in 1965 by Jack Althouse, K6NY
- Reorganized in 2013 as RFI Solutions company by AK6R and Spouse
- Product Line
 - Ferrite Core Products
 - RFI Solution Kits for hams, consumers and industry
 - Baluns, Ununs & Feedline Chokes
 - Antenna Systems (OCF, End Fed, Loop, Terminated)
 - Kurt Sterba Books/Downloads
- Distribution: Ham Radio Outlet, Direct, Ebay, WD6X
- Markets: Consumer, Commercial, and Military

Let's talk about End Feds

End Fed Workshop Topics



- Short overview of antenna feed points
- Dipole, OCF, Zepp, Loop overview
- Popular End Fed Antennas
- How to choose an End Fed Antenna that fits your needs
- Secrets of Non-Resonant End Fed Antennas
- Typical Configurations that work all the time
- Feed Line Chokes, Counterpoises and Coax Noise Filters
- Solving End Fed Antenna RFI Problems
- Q & A

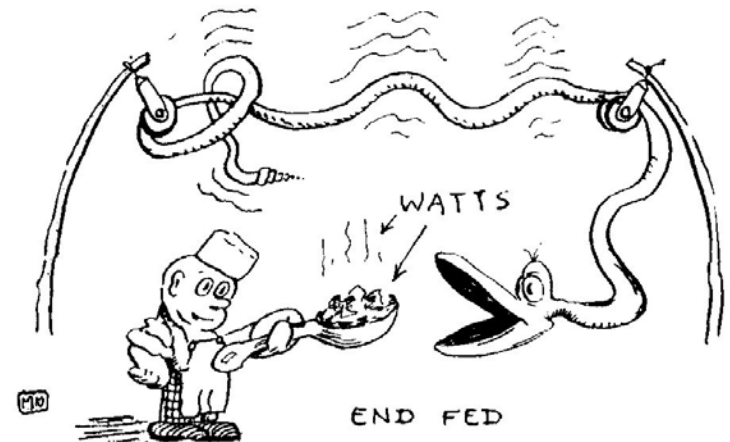

Thinking cap time.....

Antenna Feed Options

CENTER FED

OFF-CENTER FED

END FED

Resonant Dipole Examples

- Center Fed Half Wave (single band, 50-100Ω),
- Off Center Fed Feed Point (multi-band, 100-400Ω)

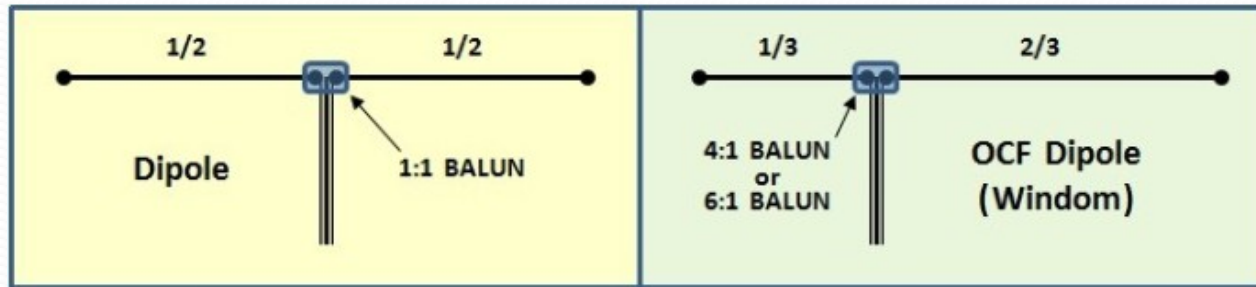

DJoIP Image

62' – 40 meters only-offset for 50Ω

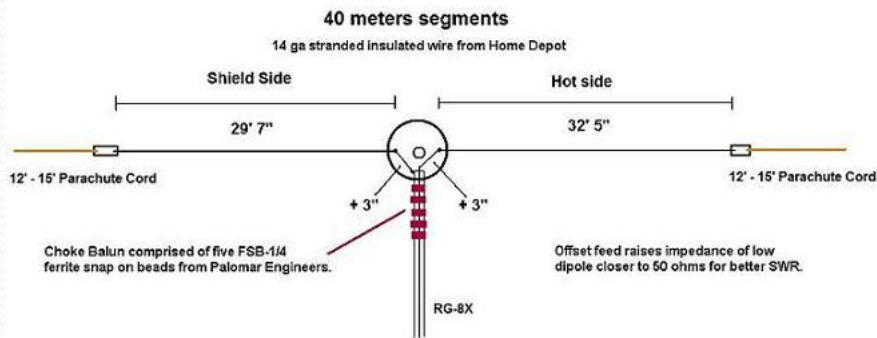

66' – 75/20 meters (loading coils)

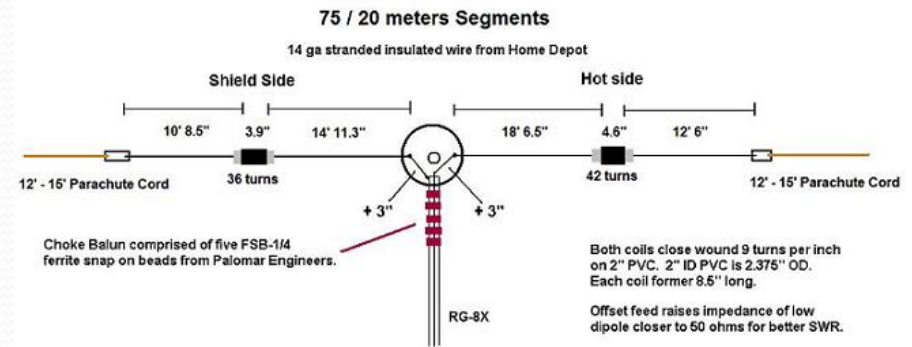

Palomar OCF

Palomar Off Center Fed (OCF)

- 80/20% (adds 15M), Resonance Compensator for 80

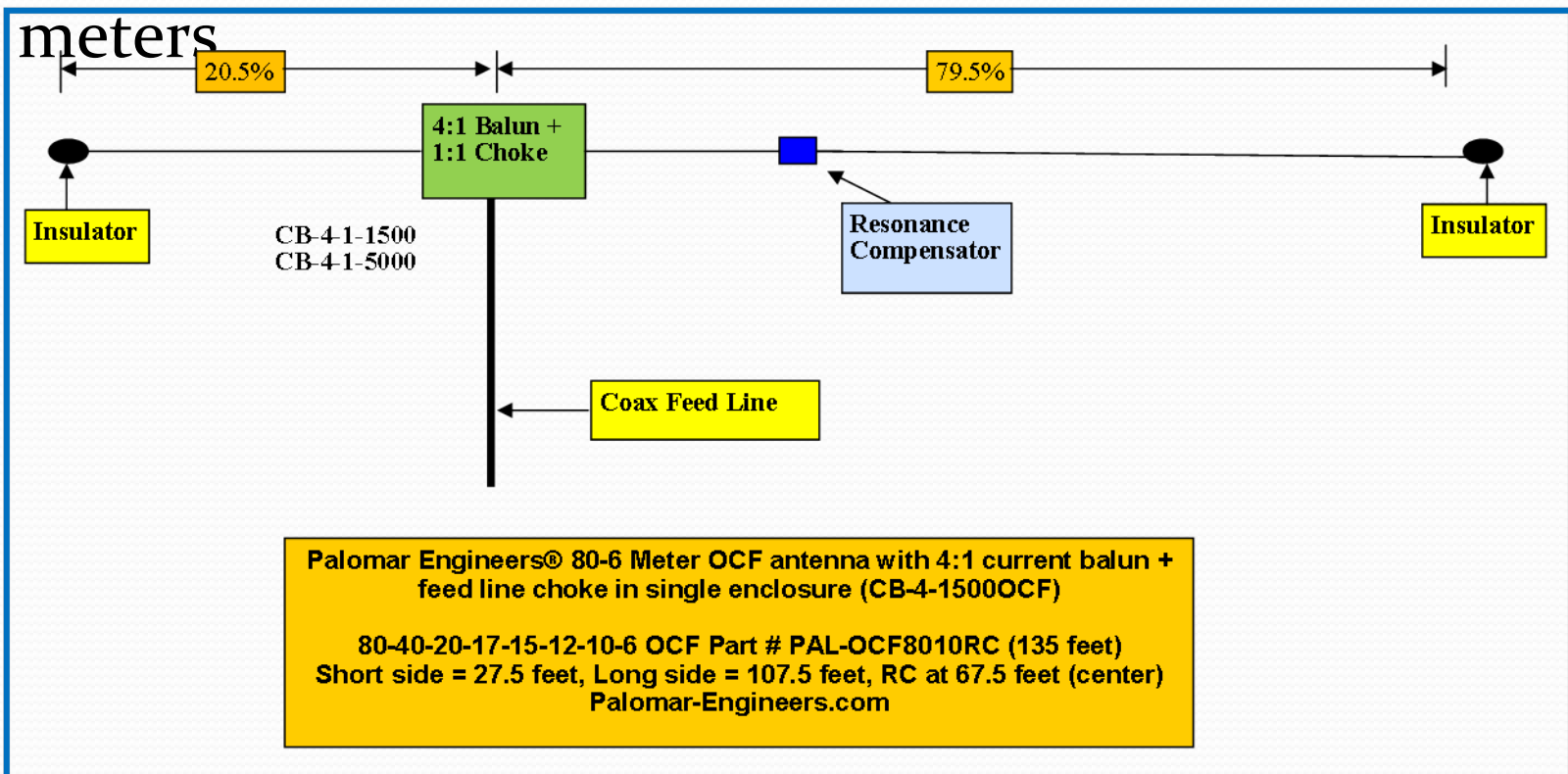

ZS6BKW – Center Fed Zepp

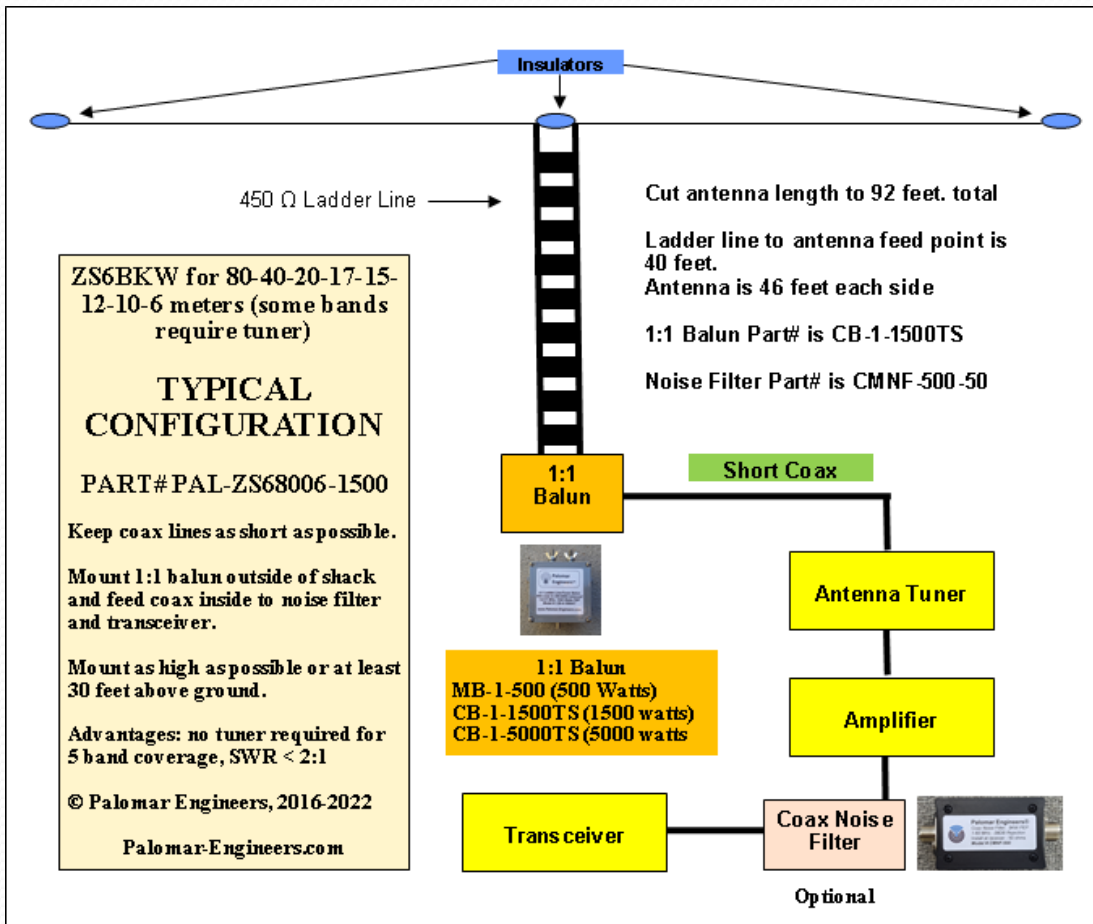

Excellent Antenna
– low loss, low noise, resonant on multiple bands, 80 meters with tuner

Use good 1:1 balun and coax noise filter for best results

Now End Feds

End Fed Antenna Types

- End Fed Zepp (aka J-Pole)
 - End Fed Half Wave
- Non-Resonate End Fed

End Fed Half Wave (Zepp)

- Pros
 - Low loss
- Cons
 - Ladder line match
 - Single band w/o antenna tuner
 - High and long
 - Needs feed line choke at coax feed point to prevent coax braid from radiating

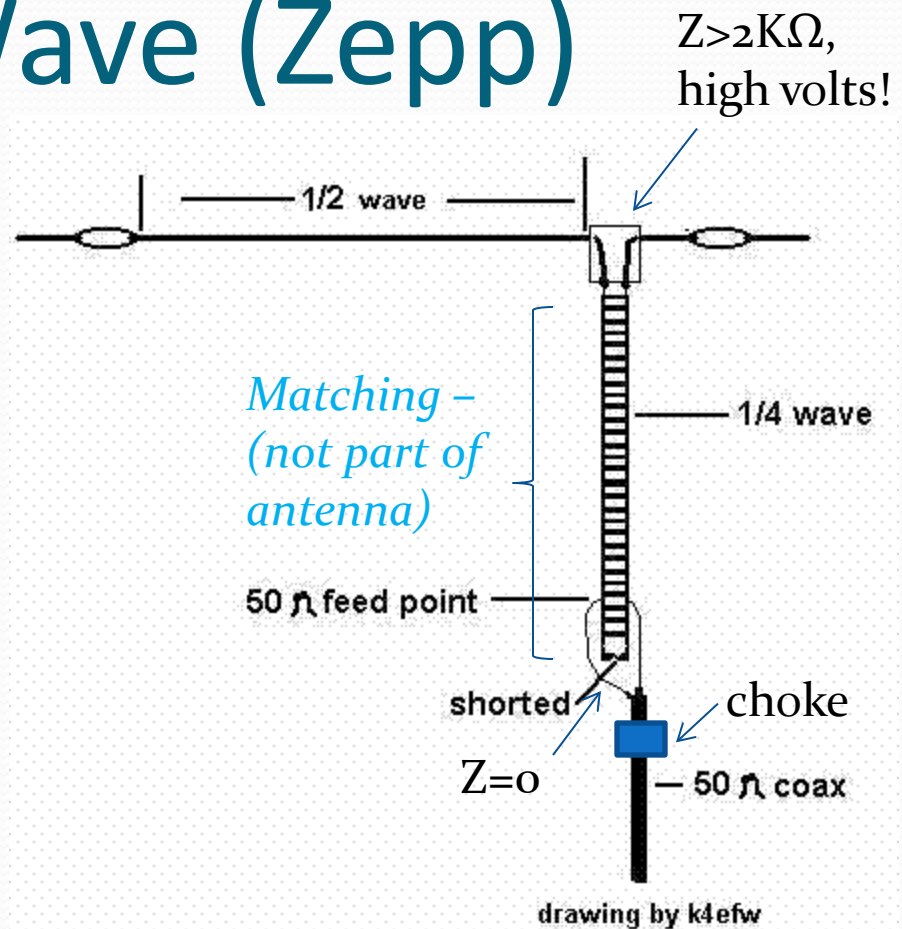

examples

EFHW Zepp Antennas



HF

R5,R7,R9



VHF



R5, R7, R9 has matching transformer and a choke in same box, skirt counterpoise



UHF

EFHW Wire Antenna

End Fed Half Wave (EFHW)

- Pros

- Multi-band – (80-40-20-15-10) may need tuner
- Hi Z feed = < ground loss %

- Cons

- Long – use coil to shorten, needs tuner for multi-band
- Complex matching unit (49:1 to 64:1 broadband unun, hi Z = high voltage!)
- Needs feedline choke near coax feed point
- Matching unit gets “HOT” with power or non-harmonic WARC bands

18-24”

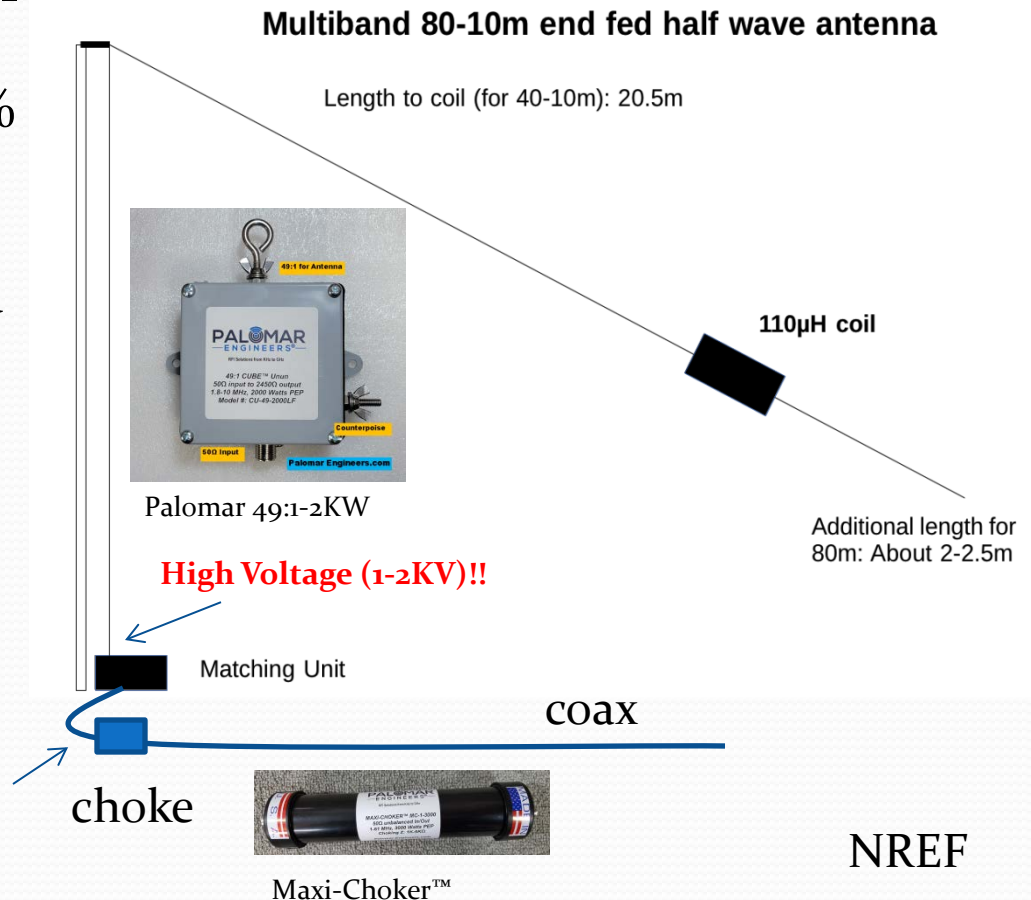

Non-Resonant End Fed Antenna

- Pros

- Shorter length (80 Meters $\geq 71'$, not 130')
- Easy to deploy
- Get WARC Bands
- Stealth for HOA
- Lots of configurations
- Safe & simple low voltage matching

- Cons

- Coax radiates (OCF)
- Counterpoises may be needed on some bands

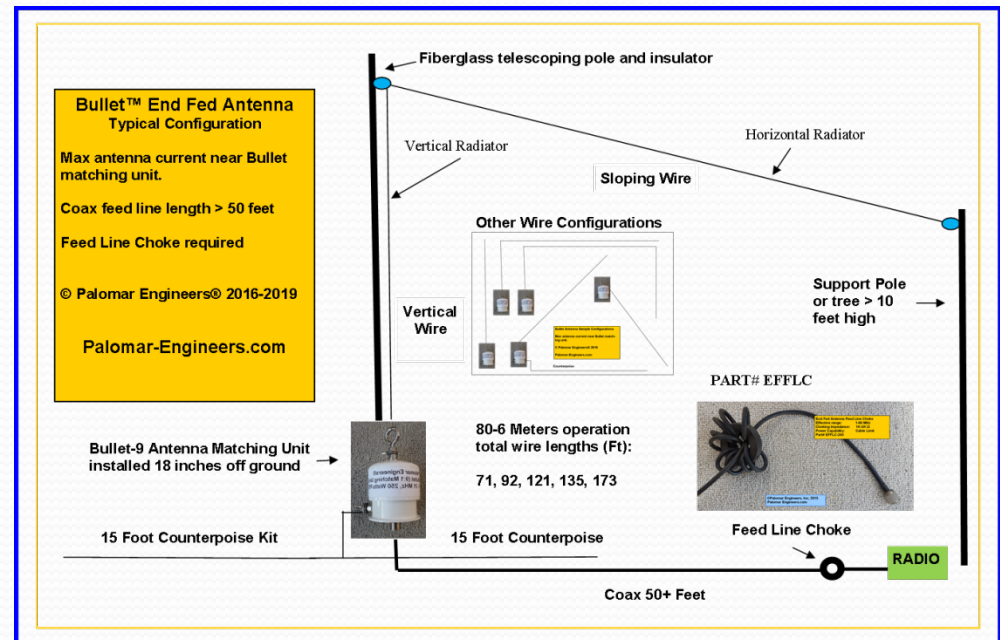

End Fed Antenna Choices Recap

- End Fed Zepp uses ladder line for matching to coax
- End Fed Half Wave – even harmonics, requires special high Z (49:1) matching unit, **high voltage** at feed point
- ✓ • Non-resonant end fed is shorter, uses simple matching, low voltage feed point, works many bands with shorter length, in less space and will work in many different configurations

Most Convenient End Fed is the Non-Resonant

Question: So how do you set up a non-resonant end fed?

Secrets of Non Resonant End Fed Antennas

How to determine the wire length to use
(antenna, coax and counterpoise lengths)

How to match the antenna to coax cable
(matching unit values and placement)

Choosing a configuration that fits the location
(vertical, sloper, inverted L, horizontal options, zig-zag)

▪ **Choosing a feed line choke or noise filter**
▪ (selection and installation)

How do these steps apply to your end fed use & location?

How long?

How to determine the wire length

- Antenna Wire – longer for better low band operation
- Coax Cable – typically 50-75% of antenna length
- Counterpoises/radials – use non-resonant length, raised, multiple with various lengths

Suggested non-resonant wire lengths for 1.8-31 MHz operation (measured from Bullet antenna wire terminal):

Bands Covered (meters)	Wire Length (feet)	Minimum Coax Length (feet)
40-30-20-15	35-43, 49-63, 70-85	35
40-30-20-17	35-45, 54-64, 67-77	35
80-40-30-20-17-15-12-10	38-44, 55, 60, 68-73	50
80-60-40-30-20-17-15-12-10	55, 68-73, 85, 92, 102, 120-125	65
160-80-40-30-20-17-15-12-10	135, 141, 155, 173, 203	100

Most Popular
71', 92', 155'

configs

Typical Non-Resonant End Fed Antenna Setup (like OCF)

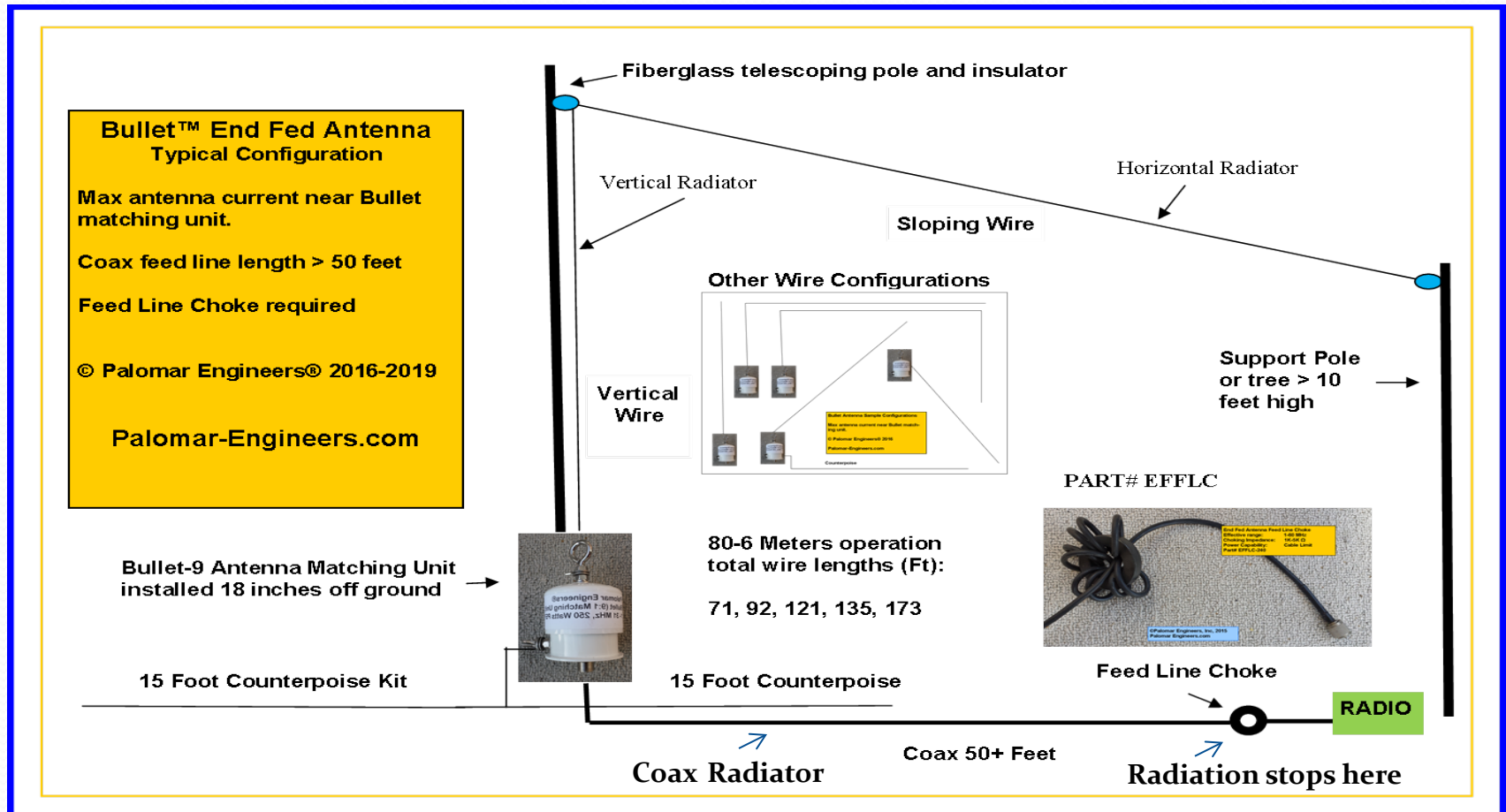

SWR Factors

End Fed SWR Factors

- Configuration shape (Inverted L, flat top, sloper, zig-zag)
- Length of coax feed line – 30% coax, 70% wire
- Feed line choke/noise filter placement – at radio end
- Top feed or bottom feed – feed sloper at top end
- Soil Conductivity – install over/near water
- Length and number of counterpoise(s) – use several with variable lengths, experiment with lengths for bands of interest (no $\frac{1}{4}$ wavelength wires!) – 30%

Some SWR plots vs antenna length →

Bullet 71 – most popular length for portable, fixed, expeditions

20-25' vertical on fiberglass pole/tree, out 52 feet to 10' or higher pole. 100 feet coax, choke at 43 foot, use tuner for 80 meters

SWR = 2:1 →

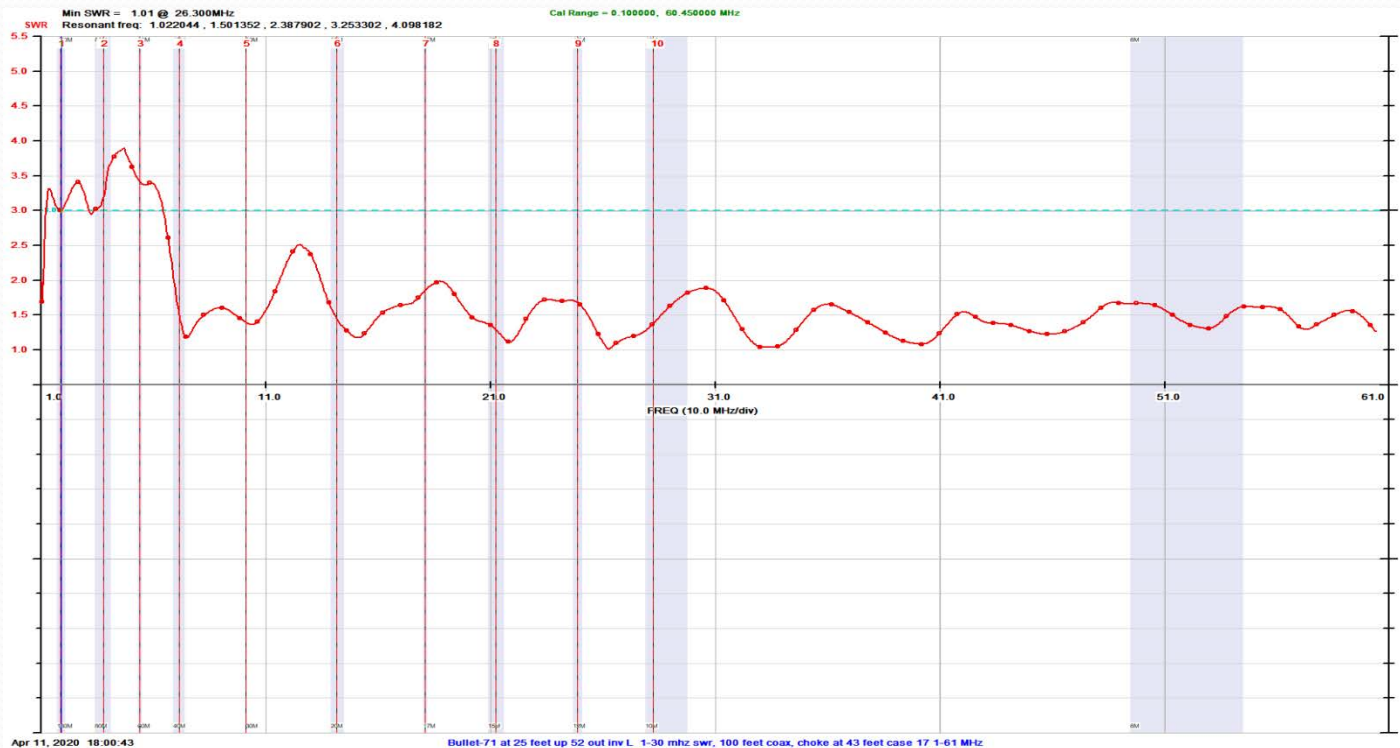

Bullet-92'- SWR & Z (at 9:1)

SWR
2:1-->

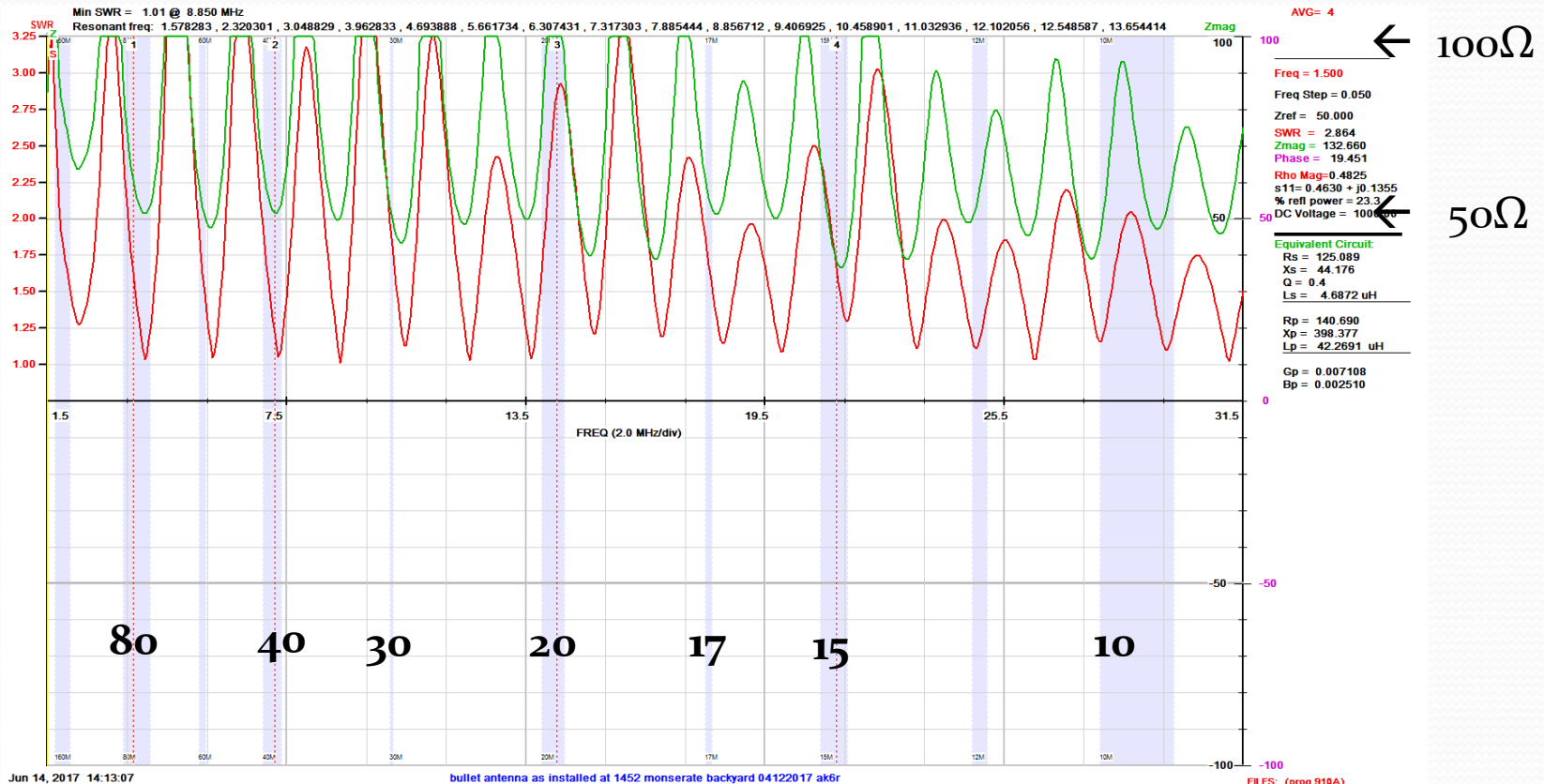

20' vertical, 72' horizontal, two 15' counterpoises, 1-31 MHz

Bullet 155 (160-6M)

Bullet 155 Inverted L (vertical 25', horizontal 130', Bullet-9U 2 feet above ground) – 100 Feet coax, choke at 70 feet from antenna feed point only – no counterpoises wires. Total antenna length = 155 + 70 = 225 feet. Feed point at 155/225 = 69% of total length. 160-6M

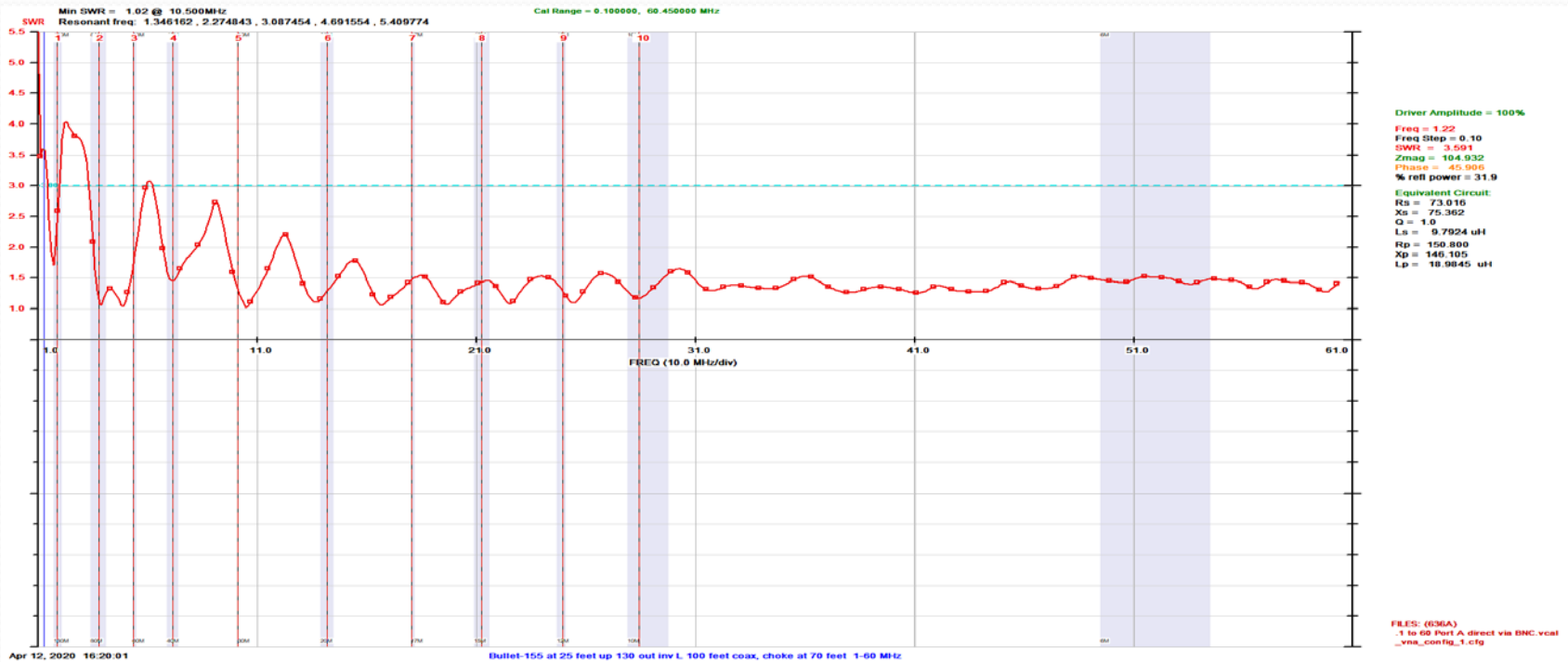

End Fed Antenna Notes

General Notes

For antennas over 92 feet, use 100 feet coax minimum and place choke in a position such that the total antenna wire is 70% of the effective length of the antenna. This choke position will be a good starting point for tuning your antenna on the bands you want to operate. Here are some examples of antenna wire and choke placement (units are in feet):

Antenna Wire length (70%)	Antenna feed point to choke length (30%)	Total Antenna Wire + coax length
71	42	113
102	44	146
110	47	157
125	54	179
135	58	193
148	63	211
155	66	221
173	74	247
203	87	290
218	93	311
268	115	383

End Fed Feedline Chokes		
EFFLC (RG-8X coax not included)	Mini-Choker MC-1-500-50 (500 watts PEP)	Maxi-Choker MC-1-3000 (3KW PEP)

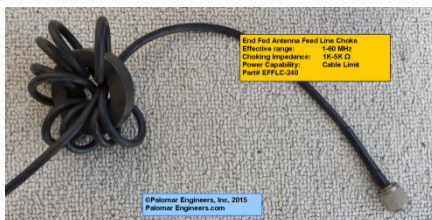

EFFLC (RG-8X coax not included)



Mini-Choker MC-1-500-50 (500 watts PEP)



Maxi-Choker MC-1-3000 (3KW PEP)

Matching

Matching the end fed antenna to coax cable

- UNUNs are your friend
 - Antenna feed point impedance: $300\text{-}900\Omega$
 - 9:1 transformer gives 33 to 100Ω at coax
- Connections for coax, antenna feed point and counterpoise
- Power Ratings – PEP to match your station

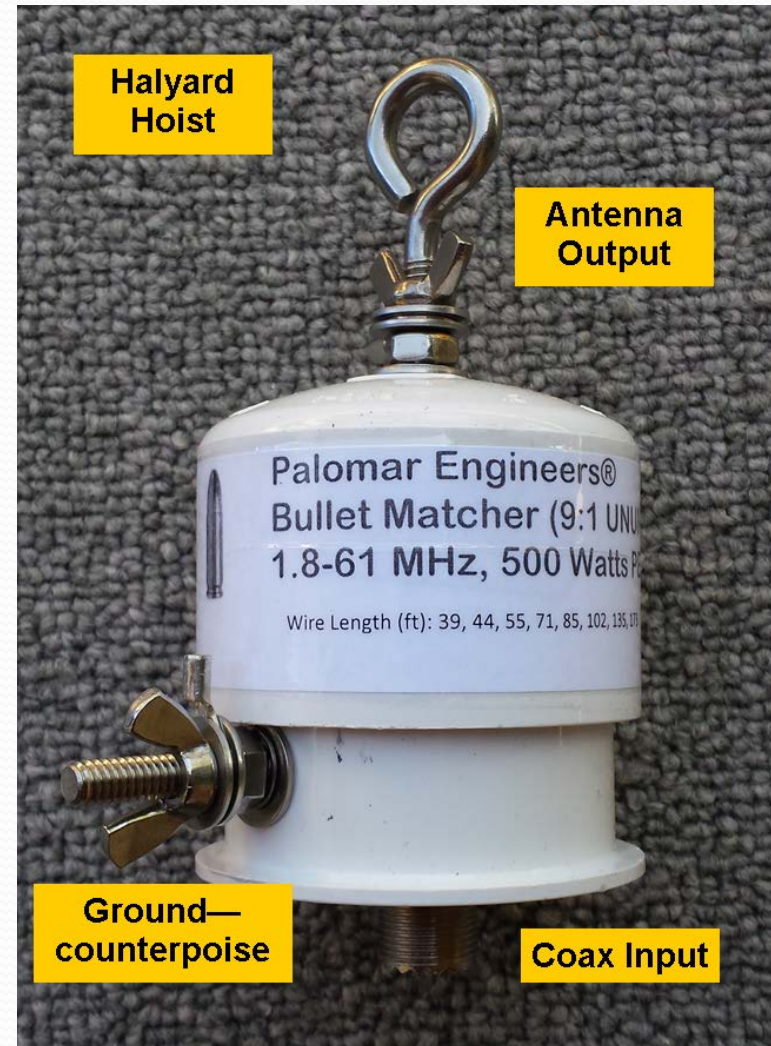

9:1 Ununs – High Power

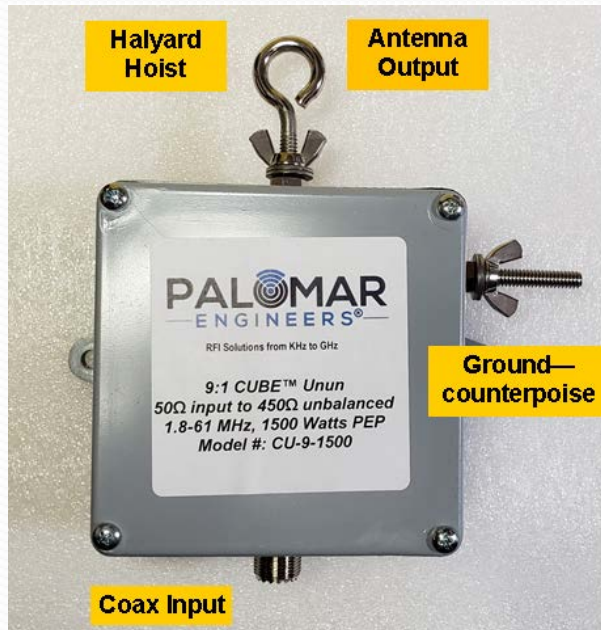

9:1 Cube - 1500 Watts PEP
available up to 5KW

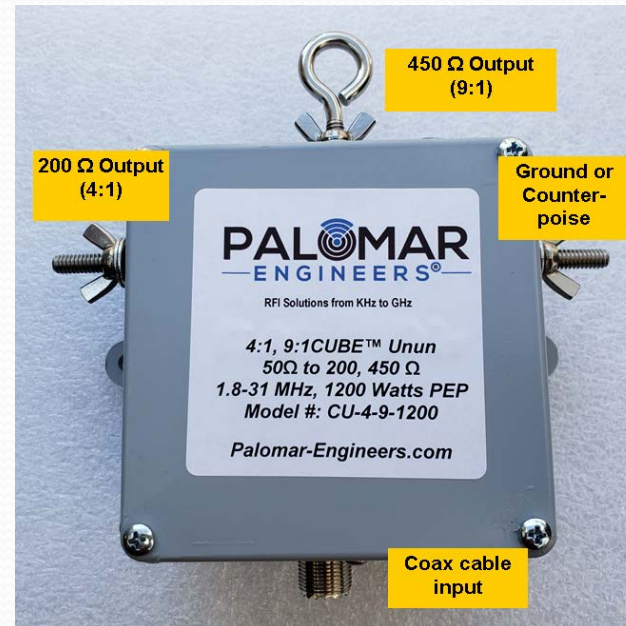

Dual Outputs - 4:1, 9:1 Cube -
1200 Watts PEP

Feedline Chokes

Coax Feed Line Chokes and Noise Filters

Lower noise floor = Higher SNR = More DX!



Typical Coax Fed Antenna System

Applies to center fed, off-center fed antennas
Coax outside braid radiation and noise reception

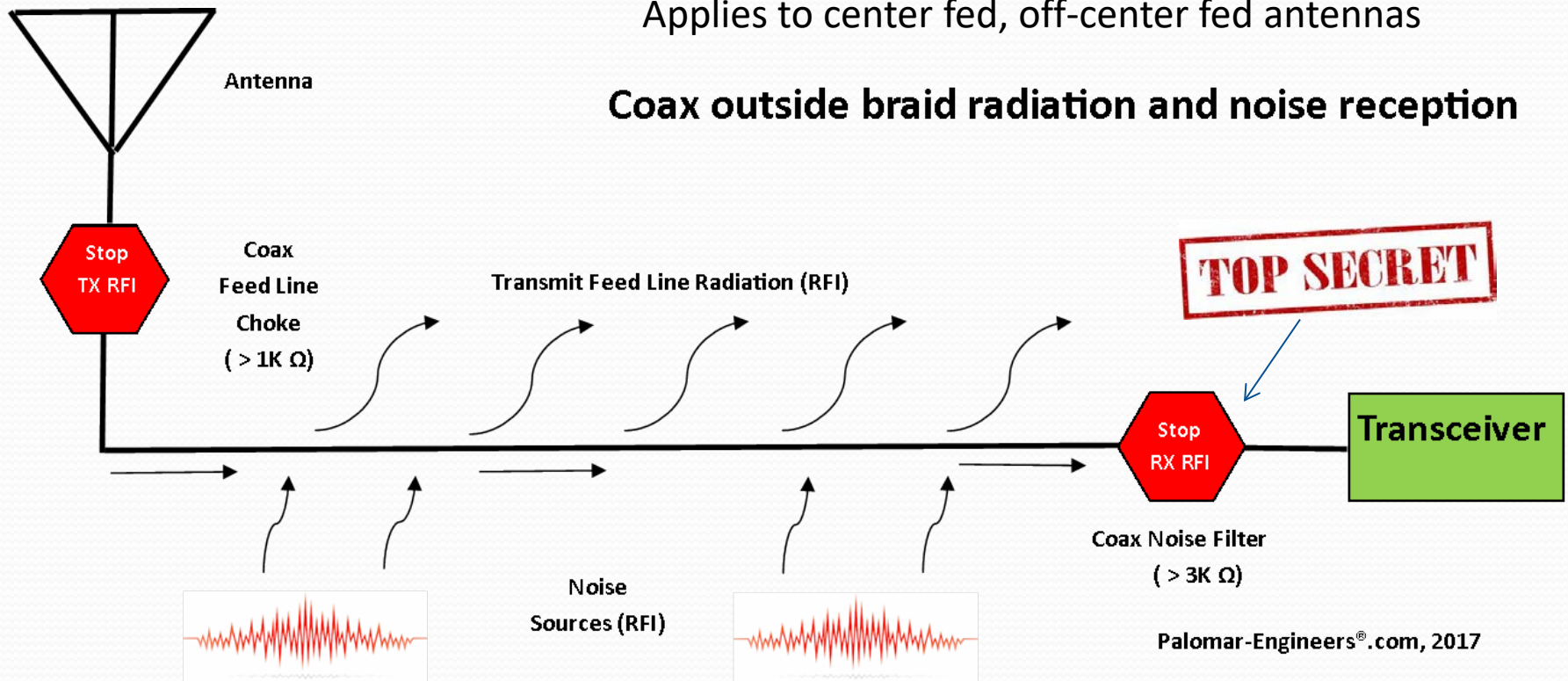

How the end fed antenna is different

Choosing an End Fed Coax Choke



Snap On Choke
500-1000 Ω -
Good

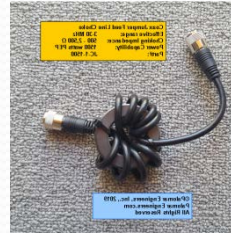

Ring Choke
1K-4K Ω
Better



Noise Filter
2K-10K Ω
Best

Criteria to Consider

- Adequate Choking Impedance (Z) > 500 Ω
- Effective Frequency Range where $Z > 500 \Omega$
- Sufficient Power Rating (PEP, Digital)
- Physical Size/Weight

First: Impedance

Choose choking impedance > 500Ω at frequency of use

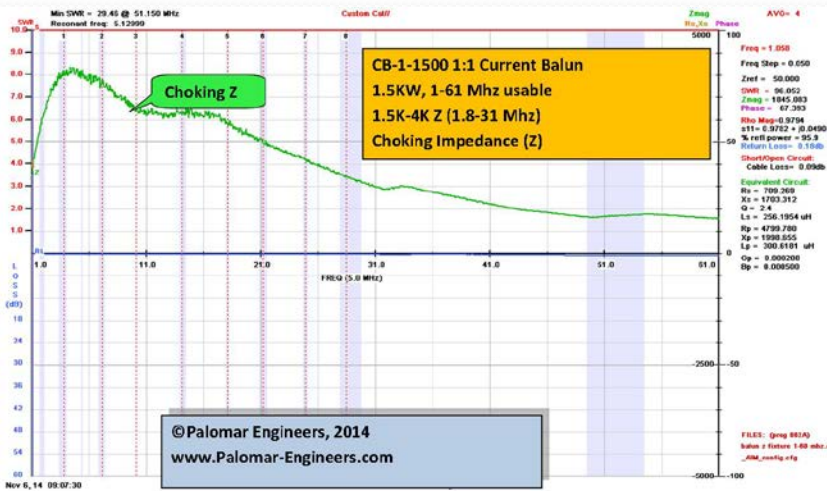

© Palomar Engineers, 2014
www.Palomar-Engineers.com

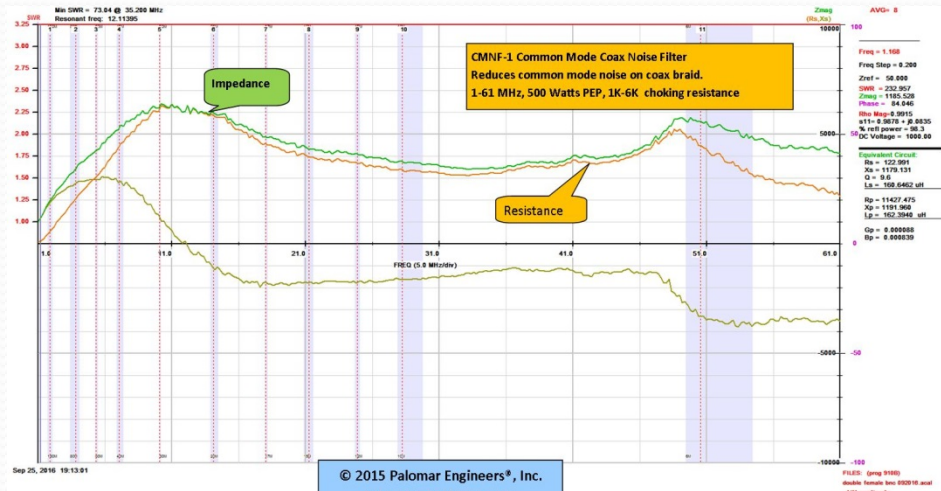

© 2015 Palomar Engineers®, Inc.
Palomar-Engineers.com

Ferrite Ring
3-60 MHz >500 Ω
500 Watts PEP
1K-4K Ω
1/2 pound, fragile



Coax Noise Filter
.1-150 MHz >2K
500 Watts PEP
1K-6K Z - 50Ω
1/2 pound, rugged



Choking R to dB attenuation

Choose choke with CMRR > 20 dB over frequency range used

CMRR =
Common Mode
Rejection Ratio

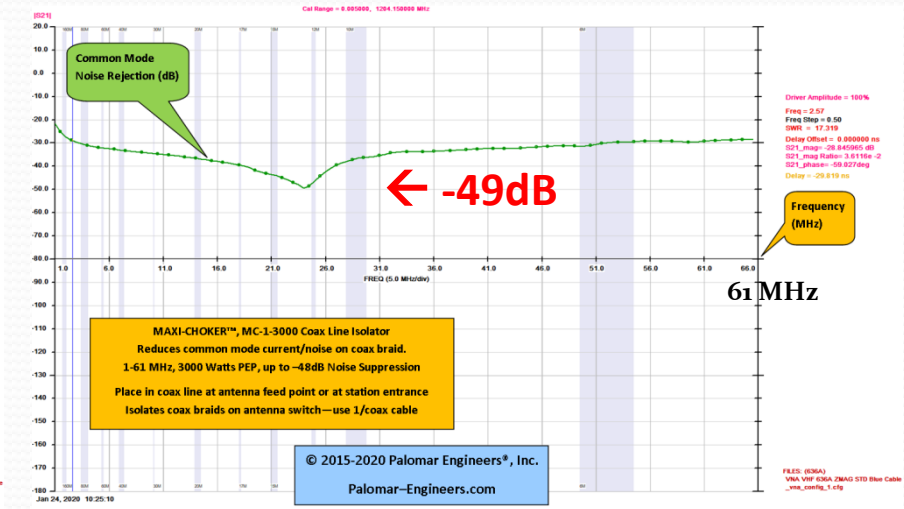
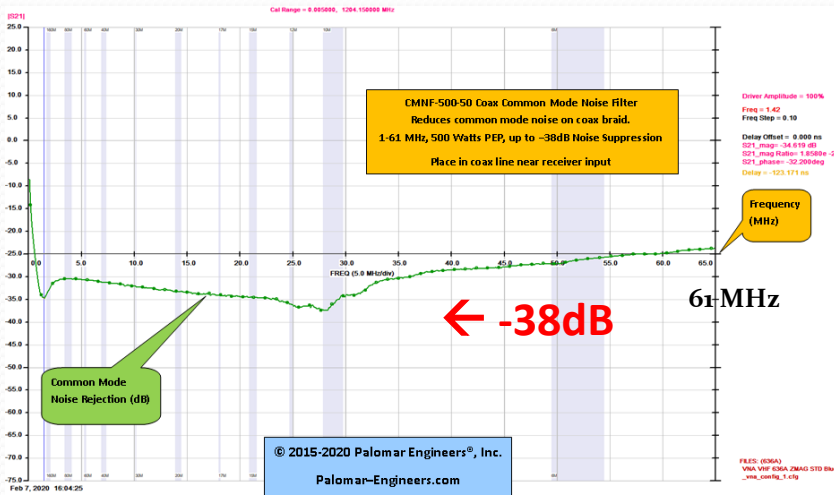

Coax Noise Filter (CMNF-500-50)
1-65 MHz >2K
500 Watts PEP, Up to 38 dB reduction
(6 “S” units of common mode noise gone!



Line isolator (part# MC-1-3000 - 3KW PEP)
1-61 MHz >2K, 3KW PEP, 1K-6K ZΩ, 1 pound. All coax lines, Optional ground, static bleeder, up to 49 dB suppression!

1 “S” unit = 6 dB, 36 dB = 6 “S” units

DO NOT BUY CHOKES with NO SPECS!

Choking Impedance vs Attenuation

- Palomar Engineers specify RFI/EMI chokes in terms of impedance (in/out), but often the customer needs to know the attenuation to choose which product best suits the application. (1 “S” unit = 6db)

Choke Impedance	Attenuation (dB)
200	-9.5
500	-15.6
1000	-20.8
1500	-24.0
3000	-29.8
5000	-34.2
10000	-40.0

Bullet Antenna Systems at HRO



Part# BAS-71



Bullet™ Antenna System with:
71 Ft End Fed Antenna (80-6M) +
Dual Wire Counterpoise Kit +
End Fed Feed Line Choke

\$130

Many more lengths and power options on our website

DIY parts too!

Bullet Antenna Parts for DIY

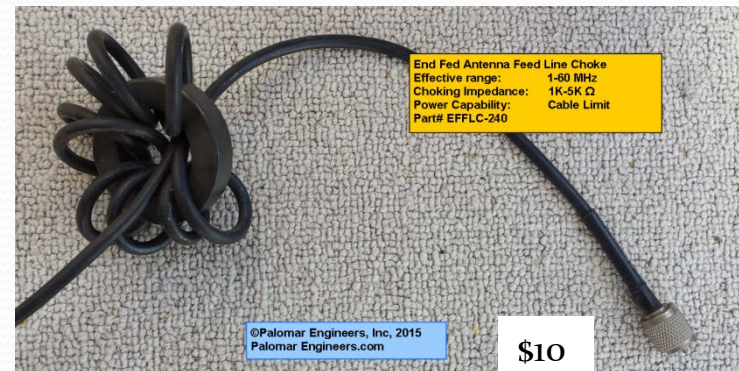

What about antenna RFI Issues?

Solving End Fed Antenna RFI Problems

Stop Transmit RFI
Reduce Receiver RFI noise



GOT WANA?



RFI Solutions from KHz to GHz

WORKED ALL NEIGHBORS

AWARDED TO

Amateur Radio Station _____

Who has caused persistent Radio Frequency Interference (RFI)
to neighbors adjacent to the radio station

Awarded this ____ day of _____, 20__

RFI Case Endorsements:



Bob Brehm, AK6R
Chief Engineer



PALOMAR ENGINEERS®

RFI Solutions from KHz to GHz

Worked All Appliances

AWARDED TO

Amateur Radio Station _____

Who has caused persistent Radio Frequency Interference (RFI)
to electronic appliances adjacent to the ham radio station

Awarded this ____ day of _____, 20__

RFI Case Endorsements:

5

10

25

50

Bob Brehm, AK6R
Chief Engineer

© 2022 Palomar Engineers®, Inc.

Palomar Engineers.com

Free download at Palomar-Engineers.com

RFI Fixes

Typical RFI Solutions

- Keep antenna (and coax) away from house wiring including AC power, Cable/Satellite feeds, telephone lines as these wires can act as receive “antennas” and overload attached electronics OR these “antennas” can transmit spurious signals (and noise) to your antenna and coax giving a high noise floor.
- Use Palomar RFI kits to solve RFI interference or noise issues in your own home or neighbor’s. See website for specific electronic device details.

Transceiver/Amp RFI Kits

Palomar RFI kits for all brands of transceivers and amplifiers

Transceiver RFI Kit

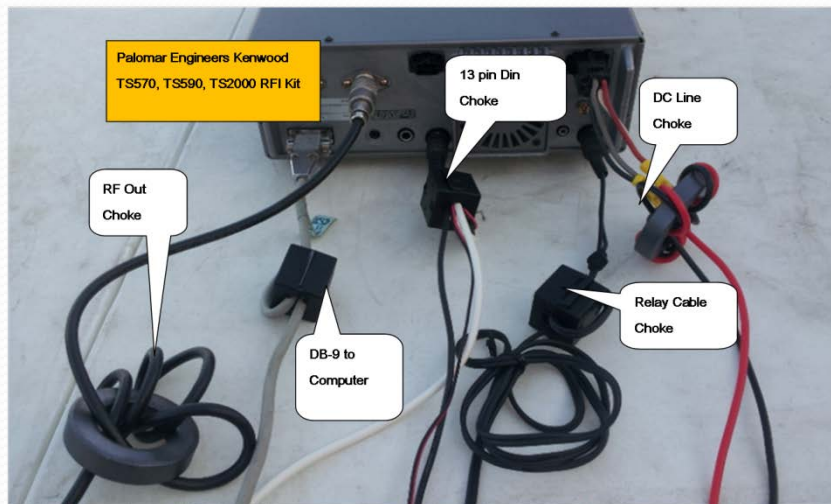

Linear Amplifier RFI Kit

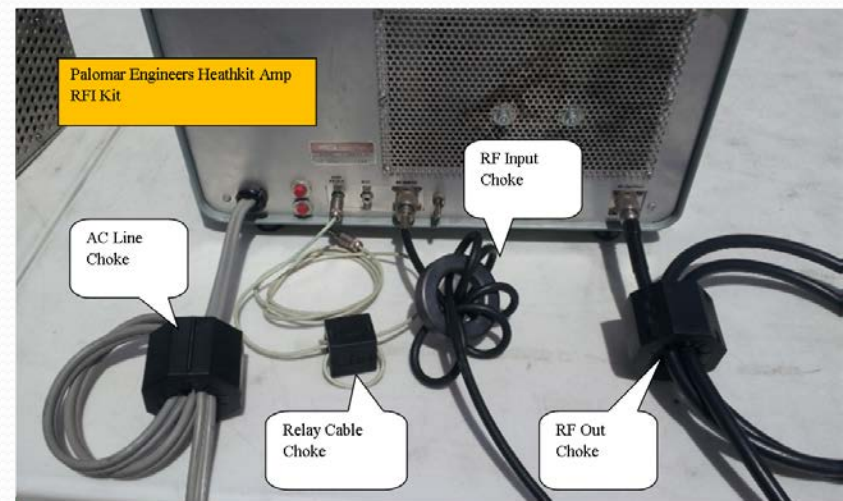

RULE # 1: Clean up your transmitter RFI first!

Neighbor's RFI

Neighborhood RFI Solutions

MY HOME or NEIGHBOR'S HOME



ALARM SYSTEM RFI



HOME THEATER RFI



COMPUTER RFI



MISCELLANEOUS RFI



GARAGE DOOR



TELEPHONE/DSL RFI

Recommendation: Use RFI kits for specific problems, have neighbor purchase and install – DO NOT make mods to neighbors equipment! MOST problems are RFI picked up by AC power/phone lines so ferrite filters work well.

QUIZ TIME

Question #1

- What characteristics of a non-resonant end fed antenna make it superior to a half wave end fed antenna?
 - A) Non-resonant will work on even and odd harmonic frequencies
 - B) Half wave has complicated matching unit with high voltage, non-resonant has simple matching and lower feed point voltage
 - C) Non-resonant can work the WARC bands
 - D) Non-resonant antennas radiate as well as resonant antennas
 - E) All of the above
 - F) None of the above
 - G) I have no idea - I was asleep during the talk

Question #2

Where do you place the feed line choke on a non-resonant end fed antenna?

- A) right below the matching unit to choke off all coax shield radiation
- B) at the radio end of the coax - about 30% of coax + antenna wire length
- C) in the middle of the coax length to balance the radiation
- D) between the antenna tuner and the transceiver
- E) end fed antennas don't need feed line chokes

Question #3



- What is one of the best kept secrets in ham radio?
 - a) Ladder line has more loss than coax
 - b) An antenna has to be resonant in the ham bands to radiate in the ham bands
 - c) All ferrites work on all frequencies, so buy the cheapest
 - d) Coax noise filters reduce common mode noise level in your receiver so you can hear more stations
 - e) All extra class hams go to heaven

OK, 1 more!

Bonus Prize Question #4

- Which company is your best source for End Fed Antennas and RFI solutions?

RFI Solutions Experts



RFI Solutions from KHz to GHz

- Website: www.Palomar-Engineers.com
- Email: Sales@Palomar-Engineers.com
- Phone: 760-747-3343
- Bob Brehm, AK6R – Chief Engineer
- This presentation available on the website.